

Official 3x3 Basketball Equipment & Software

Appendix to the 3x3 Official Rules

1. INTRODUCTION	2
2. COMPETITION MANAGEMENT SOFTWARE	2
3. BACKSTOP UNIT	2
4. BACKBOARD	3
5. BASKET RING	4
6. BASKET NET	6
7. BACKBOARD SUPPORT STRUCTURE	7
8. PADDING	7
9. SHOT-CLOCK	7
10. BASKETBALLS	8
11. GAME CLOCK & SCOREBOARD	9
12. COMPUTER HARDWARE AND SOFTWARE	9
13. PLAYING FLOOR	10
14. PLAYING COURT	11
15. LIGHTING	11
16. ADVERTISING BOARD	12

1. Introduction

The 3x3 Basketball Equipment section of the Official 3x3 Basketball Rules specifies all basketball equipment required at a 3x3 game.

This Appendix shall be used by all parties involved directly in the game as well as by basketball equipment manufacturers, local organisers and FIBA, and to establish national and international standards.

3x3 can be played both indoor and outdoor. Therefore, the weather- and water-resistant requirements (such as stainless steel or water-proof) of the equipment mentioned in this document refers only for competitions played outdoors.

2. Competition management software

Any 3x3 game shall be managed with 3x3 Event Maker (www.em.fiba3x3.com) and results; FIBA recommends the use of scores.fiba3x3.com during the event for operational efficiency and benefit of live stats. Furthermore, additional ranking points are provided at individual player basis in case score.fiba3x3.com has been used.

3. Backstop unit

There shall be 1 backstop unit (Diagram 1) placed at the end of the playing court and consisting of the following parts:

- 1 backboard
- 1 basket ring with a mounting plate
- 1 basket net
- 1 basket support structure
- Paddings
- Shot-clock integrated in the paddings

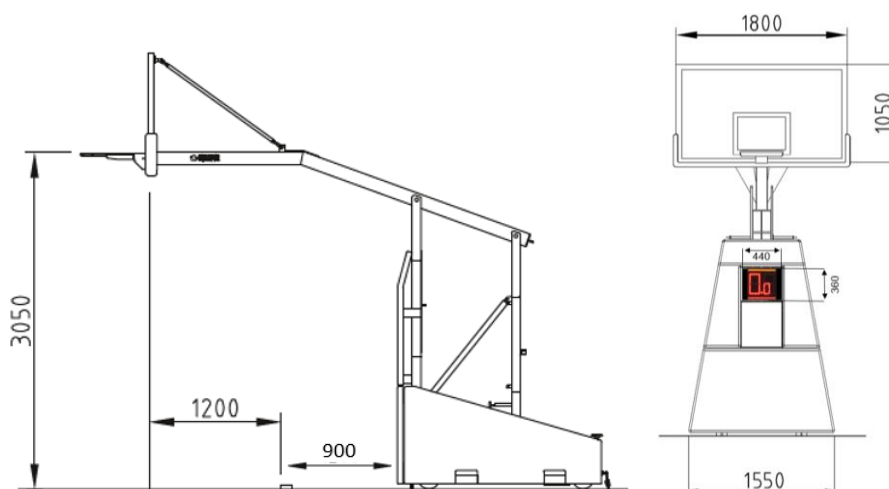

Diagram 1 – Backstop Unit

4. Backboard

4.1. The backboard shall be made of a suitable transparent material, made in one piece, water & weather resistant, non-reflective, with a flat front surface and shall:

- Have a protective framework of the backboard support structure around the outer edge
- Be manufactured such that, if broken, the pieces of glass do not split off.

4.2. The backboards shall measure 1,800mm (+ a maximum of 30mm) horizontally and 1,050 mm (+ a maximum of 20mm) vertically.

4.3. All lines on the backboards shall be:

- In white, if the backboards are transparent.
- In black, if the white painted backboards are non-transparent
- 50 mm in width

4.4. The borders of the backboards shall be marked with a boundary line and an additional rectangle behind the ring as follows

- Outside dimension: 590 mm (+ a maximum of 200mm) horizontally and 450 mm (+ a maximum of 8 mm) vertically
- The top edge of the base of the rectangle shall be level with the top of the ring and 150 mm (-2 mm) above the bottom edge of the backboard

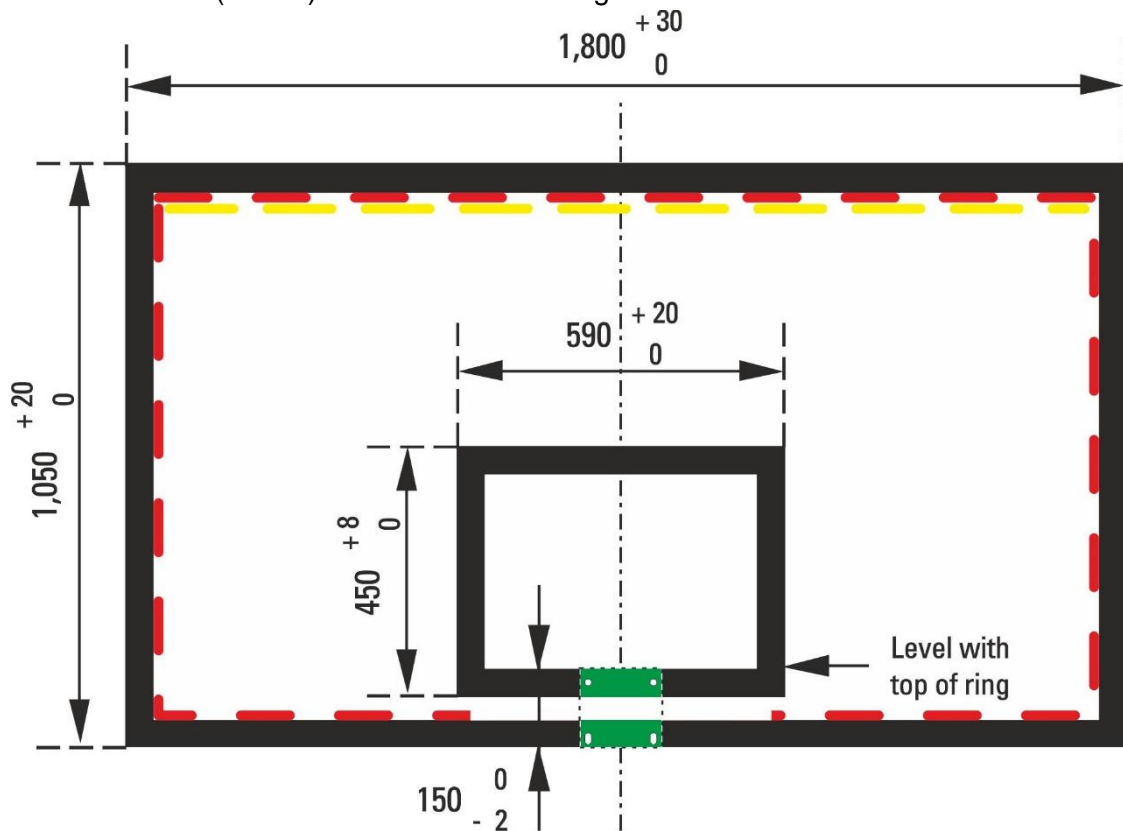

Diagram 2 – Backboard

4.5. The backboard shall be firmly mounted on the backboard support structures at right angles to the floor, parallel to the baseline. The central vertical line on the front surface, extended down to the floor, shall touch the point on the floor which lies 1'200 mm from the centre point of the inner edge of the baseline, on an imaginary line drawn at right angles to the baseline.

4.6. Rigidity test for the backboard tempered safety glass:

- When a square-shaped weight of 50 kg (250 mm wide and high, and 1,100 mm long) is applied along the centre of the backboard glass (without its frame), which is placed horizontally on two (2) parallel wooden bars at a distance of 1,200 mm from each other the maximum vertical deformation shall be 3mm.
- When a basketball is dropped onto the backboard, it shall rebound from it with a minimum rebounding height of 50%.

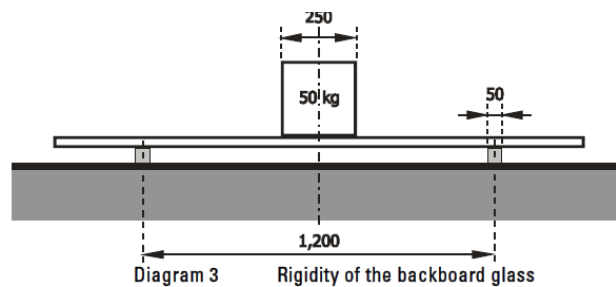

Diagram 3 – Backboard Part II

5. Basket Ring

5.1. The ring shall be made of solid stainless steel and shall:

- Have an inside diameter of a minimum of 450 mm and a maximum of 459 mm.
- Be painted orange within the following Natural Colour System (NCS) FIBA approved spectrum: S 0580-Y70R , S 0585-Y70R, S 1080-Y70R
- Have its metal a minimum of 16 mm and a maximum of 20 mm in diameter.

5.2. The net shall be attached to each ring in 12 places. The fittings for the attachment shall:

- Not have any sharp edges or gaps,
- Have gaps smaller than 8 mm, to prevent fingers from entering,

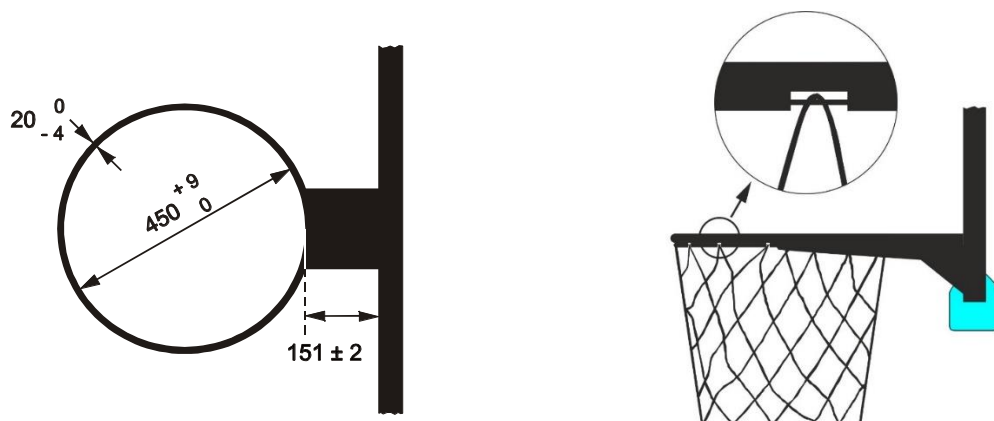

Diagram 4 - Basket Ring

- 5.3. The ring shall be fixed to the backboard support structures in such a way that any force applied to the ring cannot be transferred to the backboard itself. Therefore, there shall be no direct contact between the ring mountain plate and the backboard (Diagram 5).
- 5.4. The top edge of the ring shall be positioned horizontally, 3,050 mm (\pm a maximum of 6 mm) above the floor, equidistant from the two (2) vertical edges of the backboard.
- 5.5. The point on the inside circumference of the ring nearest the backboard shall be 151 mm (\pm a maximum of 2 mm) from the face of the backboard.

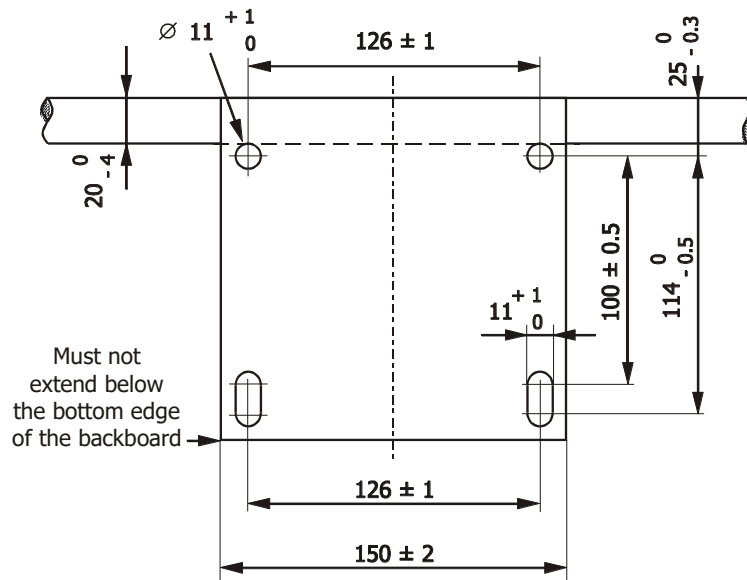

Diagram 5 – Basket Ring Mount

- 5.6. For existing basket support structures, it is recommended that the ring mountain plate be fixed to the framework according to the measurements given in Diagram 6.

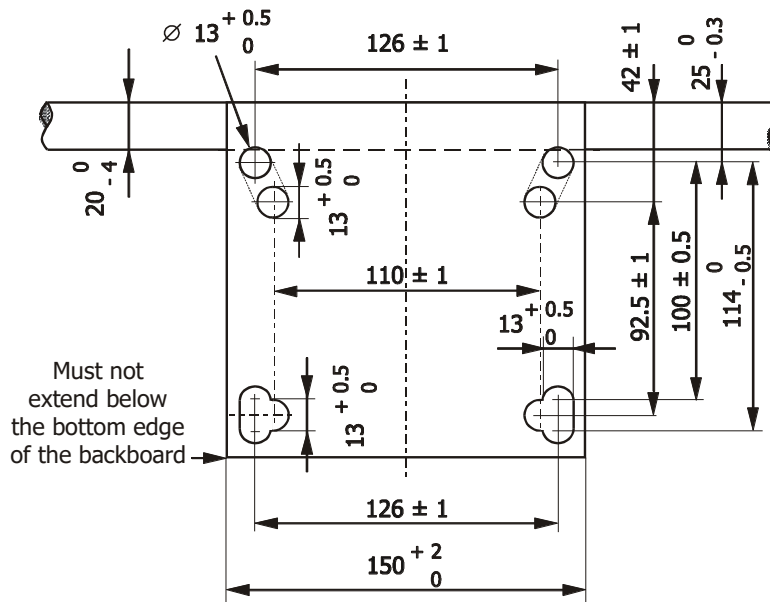

Diagram 6 – Basket Ring Mount Part II

5.7. Pressure release rings with the following specifications shall be used for

- It shall have rebound qualities close to those of the fixed ring. The pressure release mechanism shall ensure these characteristics, but not cause any damage to the ring of the backboard. The design of the ring and its construction shall be such that the players' safety is ensured.
- The pressure release ring shall have a "positive-lock" mechanism which must not disengage until a static load of a minimum of 82 kg and a maximum of 105 kg has been applied vertically to the top of the ring at the most distant point from the backboard. The pressure release ring mechanism shall be adjustable within the given static load range.
- When the pressure release mechanism is released, the front or the side of the ring shall rotate no more than 30 degrees and no less than 10 degrees below the original horizontal position.
- After release and with the load no longer applied the ring shall return automatically and instantly to its original position. No fissures and no permanent deformation of the ring shall be observed.

6. Basket net

6.1. The net shall be made of white, waterproof cord and shall be:

- Suspended from the ring.
- Manufactured so that they check the ball momentarily as it passes through the basket.
- No less than 400 mm and no more than 450 mm in length.
- Manufactured with 12 loops to attach it to the ring.

6.2. The upper section of the net shall be semi-rigid to prevent:

- The net from rebounding up through or over the ring, creating possible entanglement.
- The ball from becoming trapped in the net or rebounding back out of the net.

7. Backboard support structure

- 7.1. Only mobile or floor-fixed backboard support structures shall be used.
- 7.2. The backboard support structure shall be:
- Distance of at least 900 mm including padding, measured from the outer edge of the baseline (Diagram 1).
 - Adjusted such as that once the top edge of the ring is at a height of 3,050 mm from the playing floor, this height cannot be changed.
- 7.3. The rigidity of the backboard support structure with ring shall fulfil the requirements of the EN 1270 norms.
- 7.4. The visible vibration of the backboard support unit shall end a maximum of 4 seconds after a dunk.

8. Padding

- 8.1. The backboard and backboard support structure must be padded.
- 8.2. The padding shall be of a single solid colour, preferentially black
- 8.3. The padding shall be 20 to 27 mm thick from the front, back and side surface of the backboard. The padding shall be 48 to 55 mm thick from the bottom edge of the backboard.
- 8.4. The padding shall cover the bottom surface of the backboard and the side surface to a distance of 350 to 450 mm from the bottom. The front and back surface must be covered to a minimum distance of 20 to 25 mm from the bottom of the backboard.

The padding of the backboard support structure shall cover the bottom and side surface of the supporting arm of the backboard.

All padding shall be constructed so as to prevent limbs from being trapped.

9. Shot-Clock

9.1. The shot clock shall have:

- A separate control unit provided for the shot clock operator, with a very loud automatic signal to indicate the end of the shot clock period when the display shows zero (0).
- A display unit with a digital countdown, indicating the time in seconds only.

9.2. The shot clock shall have the ability to be:

- Started from 12 seconds.
- Stopped with the display indicating the time remaining.
- Restarted from the time at which it was stopped.
- Manually set to any number between 1 and 12.
- Showing no display, if necessary.
- Starting, stopping and resuming countdown from 99 seconds for side-competitions.

9.3. The shot clock shall:

- Be mounted in the padding on the backboard support structure with an elevation of 1.500mm above the floor level and be water-proof.
- Have the numbers of the shot clock in red colour and a minimum digit height of 200mm.
- Pass the test of protection against damage by balls according to DIN 18032-3



Diagram 7 – Shot Clock example

10. Basketballs

10.1. Only FIBA 3x3 approved ball shall be used for all categories.

10.2. Only FIBA 3x3 official ball shall be used in FIBA 3x3 Official Competitions (as defined in Book 6 of FIBA's Internal Regulations).

10.3. The outer surface of the ball shall be made of composite leather for outdoor purposes, size of 720-740 mm circumference and weight of 580-620 grams, bicolored and bouncing of 1200 mm to 1400 mm when dropped from 1800mm on playing floor.

10.4. The ball pressure shall be set between 7,5 – 8 psi.



Diagram 8 – FIBA 3x3 Official Basketball

11. Game clock & Scoreboard

11.1. The main game clock shall:

- Be a digital countdown clock with an automatic signal sounding for the end of the game as soon as the display shows zero (00:00.0).
- Have the ability to indicate time remaining in minutes and seconds; as well as tenths (1/10) of a second only during the last minute of the game.
- Be placed so that it is clearly visible to everyone involved in the game, including the spectators.

11.2. An LED monitor screen, minimum 32" shall be used, which will be connected to the scores.fiba3x3.com

11.3. The scoreboard will show:

- The digital countdown game clock.
- The points scored by each team
- The team's names.
- The number of team fouls
- Foul bonus situation
- Optionally, events logo or hashtag; as well as sponsors' logo

11.4. In addition, the scoreboard shall;

- Not have any sharp edges or burrs.
- Be mounted securely.
- Have specific protection, if necessary, which shall not impair the readability of the scoreboard.

12. Computer hardware and software

If real-time scoring and statistics are provided from the venue, the following technical infrastructure must be followed

- Internet connection must be available and reliable

- The scoring and statistics computer must have enough of processing power and memory
- Recommended browsers such as Chrome must be used with the latest version
- Computer must be freed from any other software that may slow down the speed of processing and the scoring or statistics computers are not to be used for other purposes at the same time.

More specific details are provided in the Digital Tools section of help.fiba3x3.com

- <http://help.fiba3x3.com/en/support/solutions/articles/35000012970-what-kind-of-computer-do-i-need-for-running-scores-fiba3x3-com->
- <http://help.fiba3x3.com/en/support/solutions/articles/35000012969-do-i-need-an-internet-connection-to-use-scores-fiba3x3-com->
- <http://help.fiba3x3.com/en/support/solutions/articles/35000012971-which-browser-should-i-use-for-scores-fiba3x3-com->

13. Playing floor

13.1. The playing floor surface shall be made of:

- FIBA-approved floors when playing indoors
- FIBA approved floors specifically for outdoors when playing outdoors.

13.2. The court shall be 15x11 meters (playing surface) + additional boundary of 2m baseline, 1,5m (exceptionally minimum of 1m) short side and 1m for the long side opposite the backstop

13.3. The playing floor shall be marked with 50mm white lines (in any case, clearly visible)

13.4. The playing field shall be colored in 2 colors: key and 2 point area in one color, the remaining playing area in another color. The colors recommended by FIBA are as in diagram 9.

13.5. The logo on official courts to mark the check-ball area will be placed and with the size as shown in diagram 9.

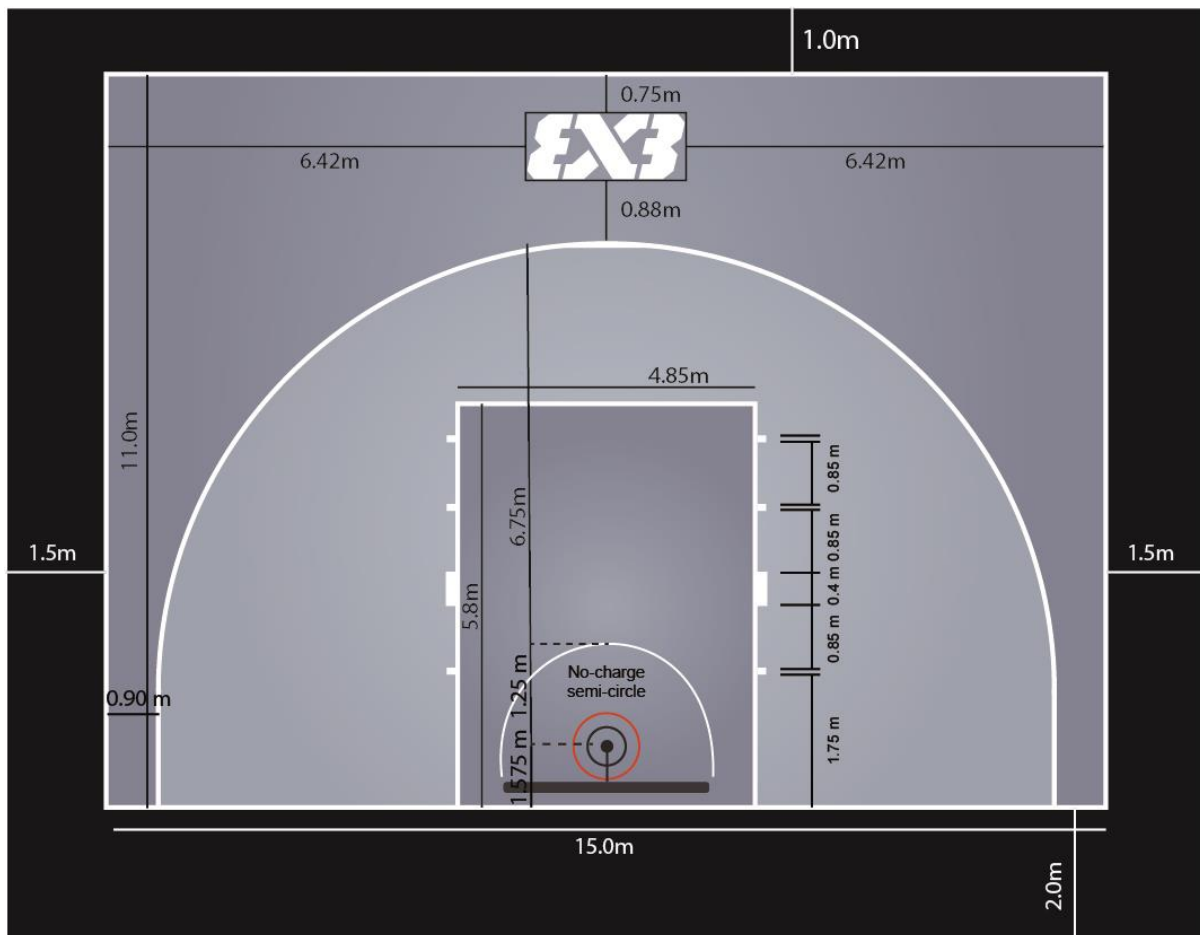

Diagram 9 – Playing floor

14. Playing court

- 14.1. All spectators must be seated at a distance of at least 2,000 mm from the outer edge of the boundary line of the playing court.
- 14.2. The height of the lowest obstruction above the playing floor shall be a minimum of 7 m.
- 14.3. In case the playing court is installed on a platform, the maximum elevation at any spot can be 500mm.

15. Lighting

- 15.1. The vertical illuminance (EC) (illuminance towards the main camera) and (EV) (illuminance towards the mobile cameras) are a key parameter for the picture quality. If there are varying levels of vertical illuminance at different positions on the playing court then it can be disturbing when panning the camera. It is therefore essential that there is total uniformity in the distribution of the vertical illuminance over the entire playing court (also called uniformity of the vertical illuminance).
- 15.2. The vertical illuminance shall be kept as constant as possible in the four main directions facing the sides of the playing court where the cameras are generally located.
- 15.3. Lighting requirements and recommendations;
- 15.4. The venue lighting must be designed for television broadcasting
- 15.5. The playing court shall be uniformly and adequately lit. The lighting shall be of minimum 1.200 lux in playing area

16. Advertising board

This only applies in case advertising boards are used.

- 16.1. Have no burrs and all edges shall be rounded off.
- 16.2. Be in accordance with the national safety requirements for electrical equipment in the respective country.
- 16.3. Be non-flammable.